

USE LU21933 WHEN INSTALLING GPO

FACTORY ONLY INSERTABLE MODULES
REFER PAGE 2 FOR
MODULE CONFIGURATION

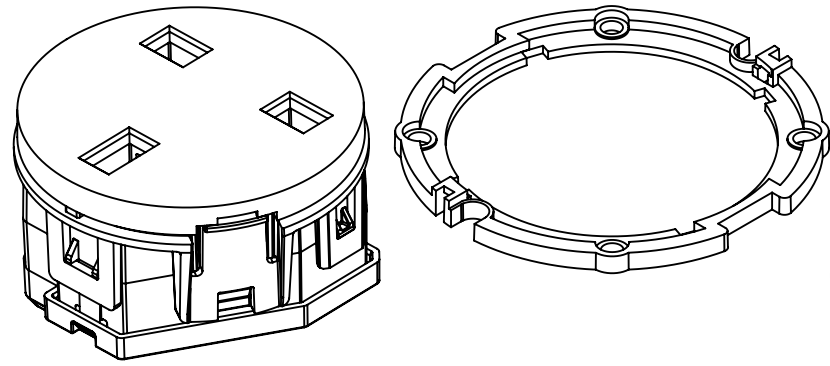

BS NON FUSED SOCKET OUTLET = C

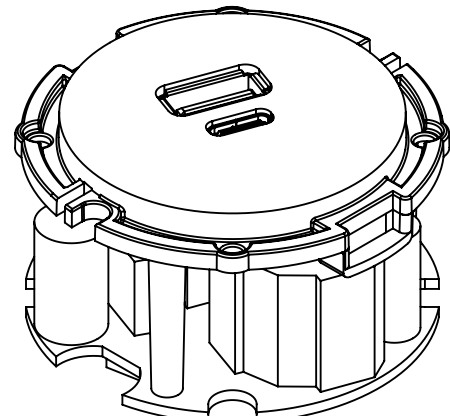

USB AC MODULE = U

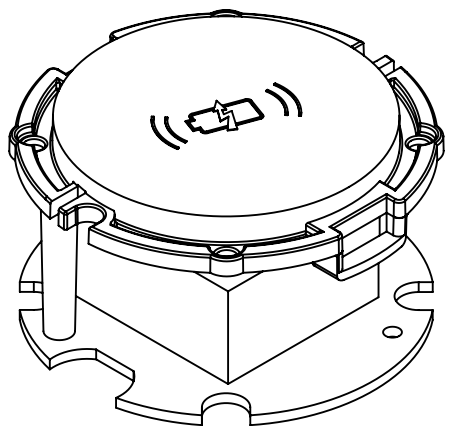

WIRELESS CHARGING MODULE = W

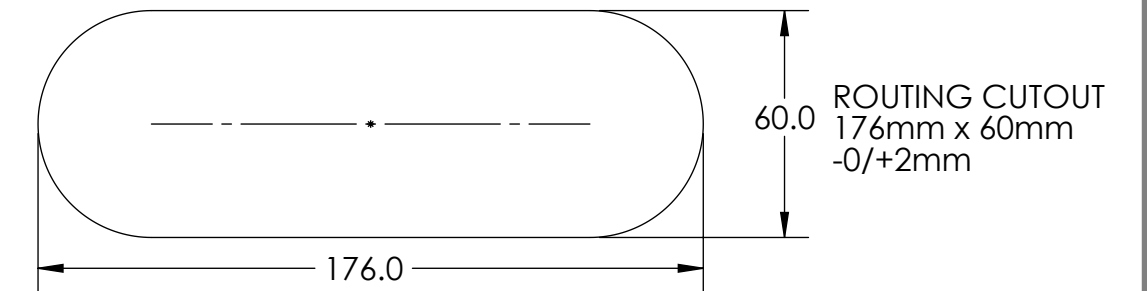
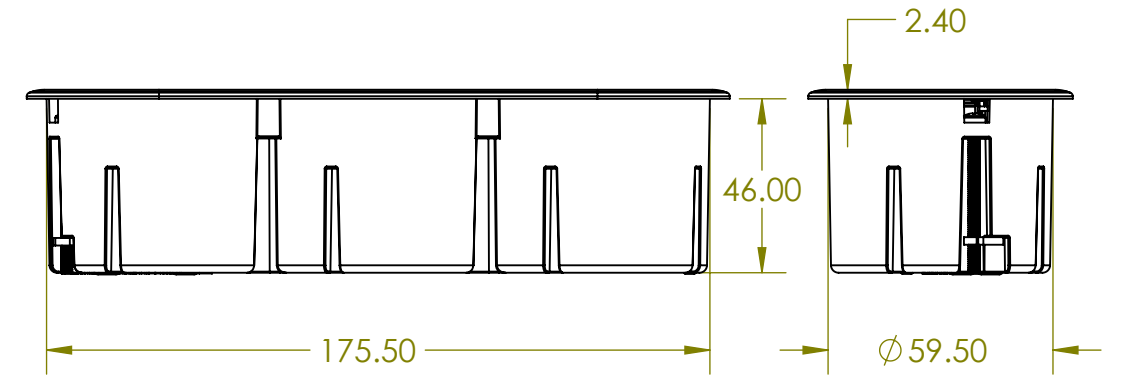
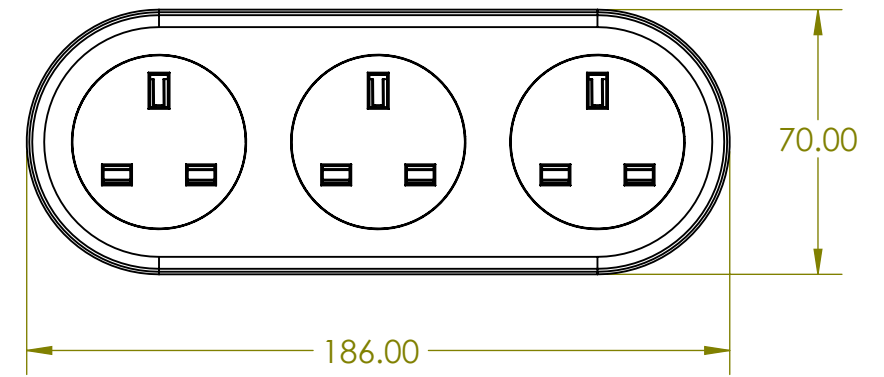
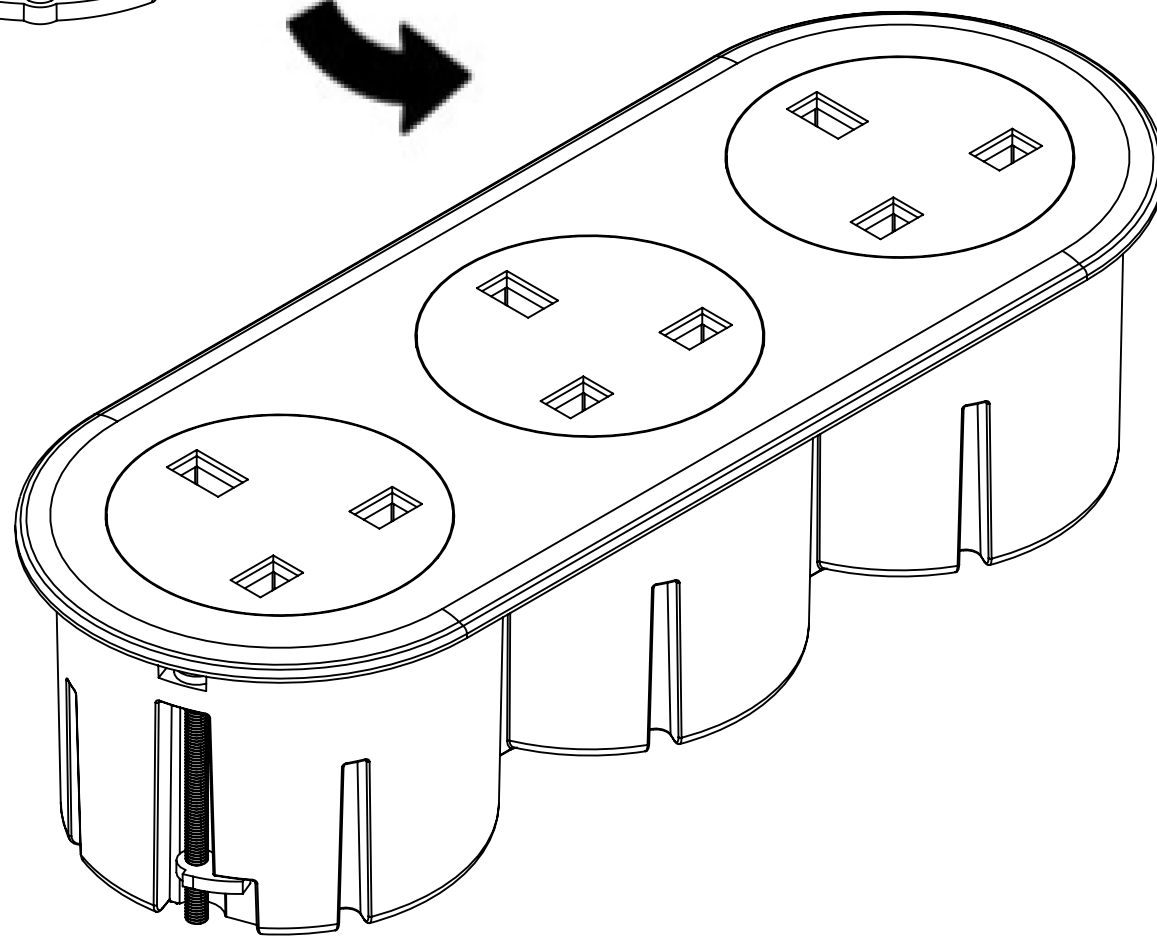

ROUTING CUTOUT
176mm x 60mm
-0/+2mm

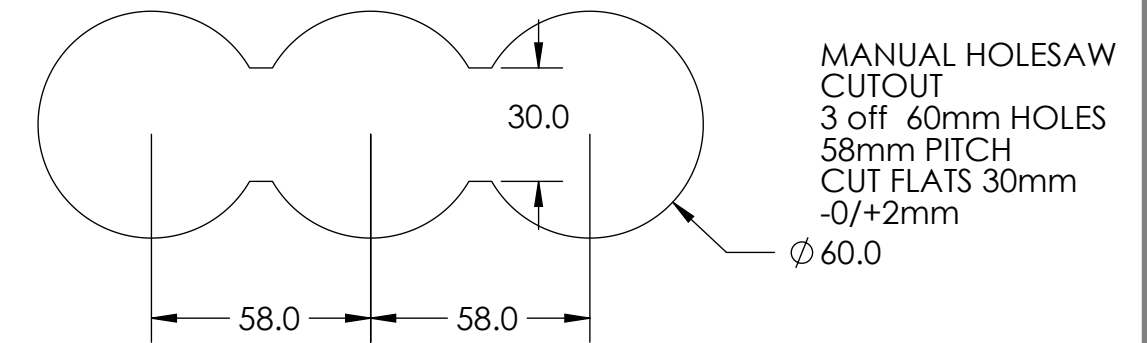

MANUAL HOLESAW
CUTOUT
3 off 60mm HOLES
58mm PITCH
CUT FLATS 30mm
-0/+2mm

1	RELEASED FOR PRODUCTION	2/09/2019	AP	
REV	DESCRIPTION	DATE	DRWN	APPV
REVISIONS				

CUSTOMER SIGNATURE:
MATERIAL: PC FR
FINISH: TEXTURED
COLOUR: WHITE OR BLACK
THIS DRAWING & ASSOCIATED CAD FILES ARE ISSUED IN THE STRICTEST CONFIDENCE AND ARE ONLY TO BE USED IN THE COMMERCIAL INTERESTS OF CMS ELECTRACOM PTY LTD

TOLERANCES UNLESS OTHERWISE STATED:

X ±0.5
X.X ±0.2
X.XX ±0.1
X.XXX ±0.05
ANG ±0.5°

DRAWN IN mm TO AS1100 DO NOT SCALE



TITLE:
UK NON FUSED MULTI 3 ECHO ASSEMBLY

DRAWING: LU36241	REV: 1	A3
SCALE 1:2	SHEET 1 OF 4	

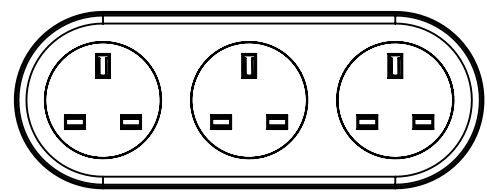

ETC1C1C1XXXDXX

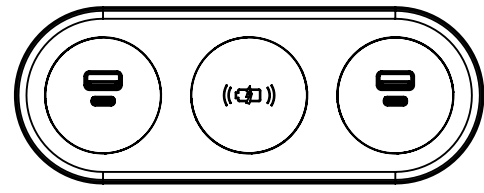

ETUWUXXXDXX

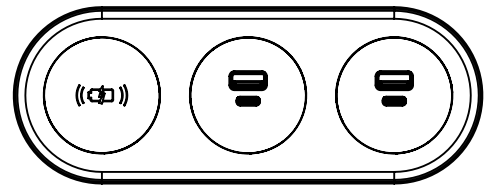

ETWUWXXXDXX

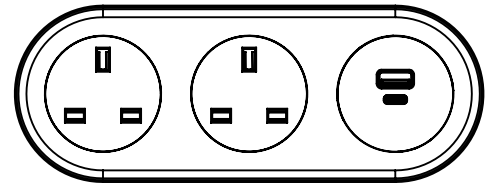

ETC1C1UXXXDXX

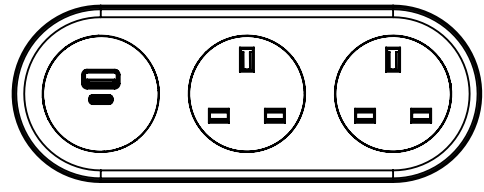

ETUC1C1XXXDXX

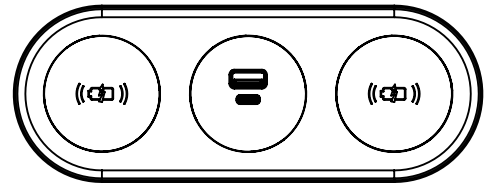

ETWUWXXXDXX

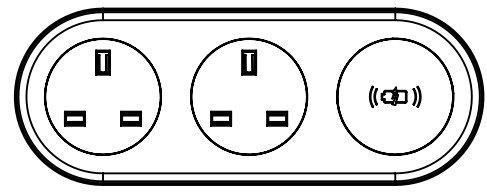

ETC1C1WXXXDXX

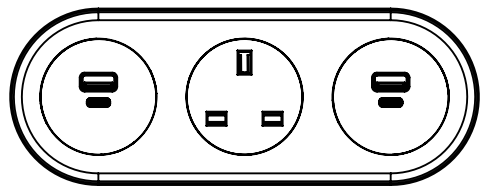

ETUC1UXXXDXX

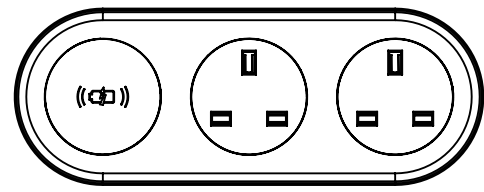

ETUC1C1XXXDXX

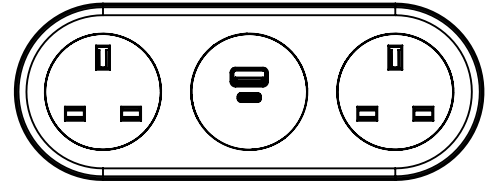

ETC1UC1XXXDXX

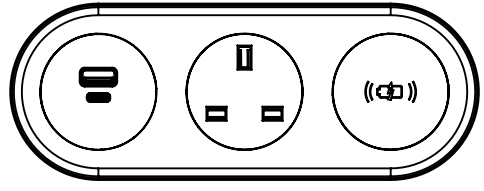

ETUC1WXXXDXX

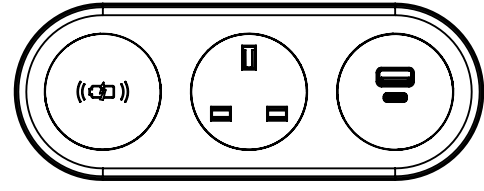

ETWC1UXXXDXX

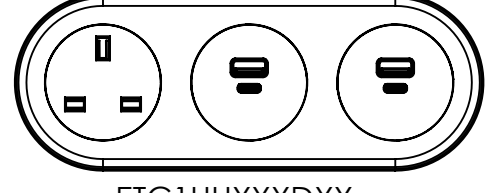

ETC1UWXXXDXX

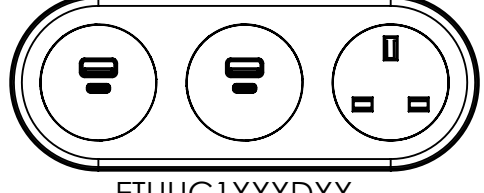

ETUUC1XXXDXX

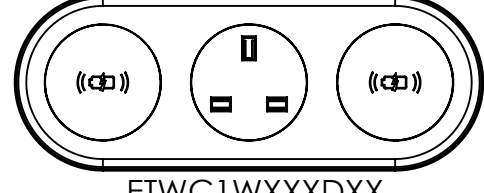

ETWC1WXXXDXX

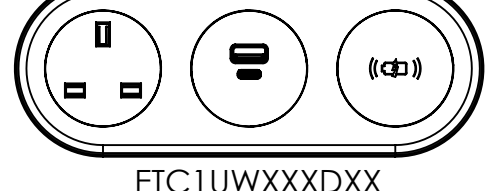

ETC1UWXXXDXX

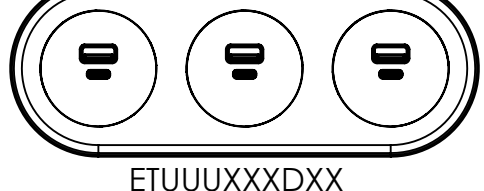

ETUUUXXXDXX

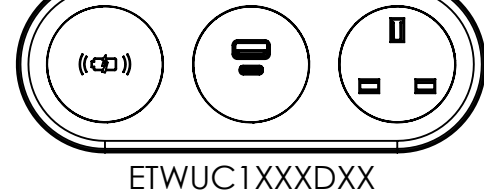

ETWUC1XXXDXX

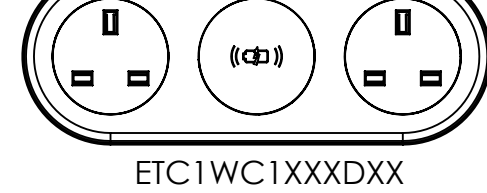

ETC1WC1XXXDXX

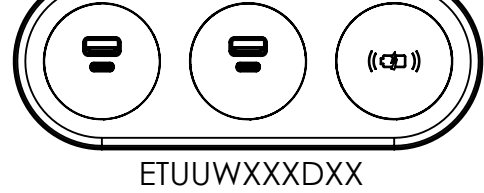

ETUUWXXXDXX

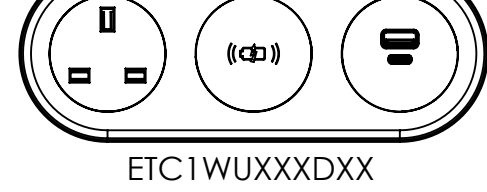

ETC1WUXXXDXX

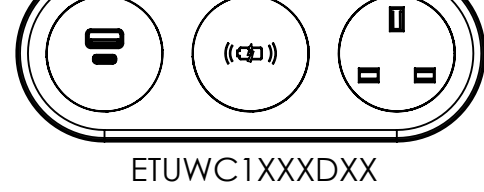

ETUWC1XXXDXX

NOTE:

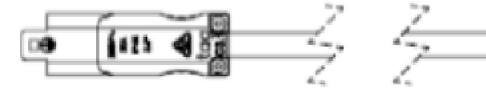

CABLE TYPE: 3 CORE x 1.5mm²
DESCRIPTION: C-CONNECTOR LEAD
COLOUR: WHITE OR BLACK
(REFER TO PURCHASE ORDER)

LENGTH (mm):	xx	LENGTH (mm)
	05	500
	10	1000
	15	1500
	20	2000
	25	2500
	30	3000
	35	3500
	40	4000
	45	4500
	50	5000

NOTE:

SIRIM APPROVED

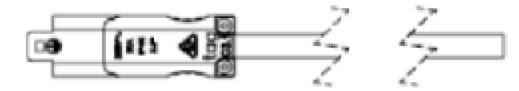

CABLE TYPE: 3 CORE x 1.5mm²
DESCRIPTION: C-CONNECTOR LEAD
COLOUR: WHITE OR BLACK
(REFER TO PURCHASE ORDER)

LENGTH (mm):	xx	LENGTH (mm)
	05	500
	10	1000
	15	1500
	20	2000
	25	2500
	30	3000
	35	3500
	40	4000
	45	4500
	50	5000

NOTE:

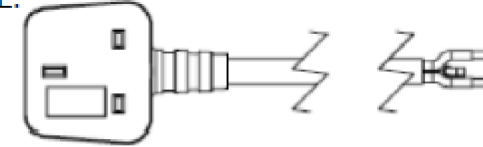

CABLE TYPE: 3 CORE x 1.5mm²
DESCRIPTION: BRITISH 13A PLUG LEAD
COLOUR: WHITE OR BLACK
(REFER TO PURCHASE ORDER)

LENGTH (mm):	xx	LENGTH (mm)
	05	500
	10	1000
	15	1500
	20	2000
	25	2500
	30	3000
	35	3500
	40	4000
	45	4500
	50	5000

NOTE:

SIRIM APPROVED

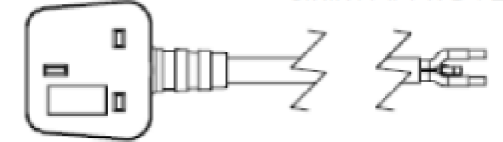

CABLE TYPE: 3 CORE x 1.5mm²
DESCRIPTION: BRITISH 13A PLUG LEAD
COLOUR: WHITE OR BLACK
(REFER TO PURCHASE ORDER)

LENGTH (mm):	xx	LENGTH (mm)
	05	500
	10	1000
	15	1500
	20	2000
	25	2500
	30	3000
	35	3500
	40	4000
	45	4500
	50	5000

PART NUMBER: ETC1C1C1XxxDXX

NOTE - X - LEAD TYPE (C SERIES CONNECTOR = C OR 3PIN BS PLUG = G)

xx - LENGTH - 05 / 10 / 15 / 20 / 25 / 30 / 35 / 40 / 45 / 50

XX - COLOUR - WT / BK

CUSTOMER SIGNATURE:	TOLERANCES UNLESS OTHERWISE STATED:		
MATERIAL: PC FR	X ±0.5 X.X ±0.2 X.XX ±0.1 X.XXX ±0.05 ANG ±0.5°	COPYRIGHT © 2015	
FINISH: TEXTURED		TITLE: UK NON FUSED MULTI 3 ECHO ASSEMBLY	
COLOUR: WHITE OR BLACK		DRAWING: LU36241	REV: 1
THIS DRAWING & ASSOCIATED CAD FILES ARE ISSUED IN THE STRICTEST CONFIDENCE AND ARE ONLY TO BE USED IN THE COMMERCIAL INTERESTS OF CMS ELECTRACOM PTY LTD	DRAWN IN mm TO AS1100 DO NOT SCALE	SCALE 1:2	SHEET 2 OF 4
			A3