

FRONT VIEW

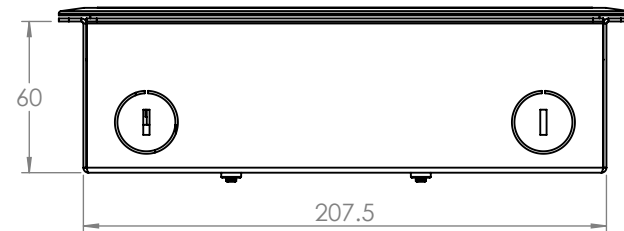

END VIEW

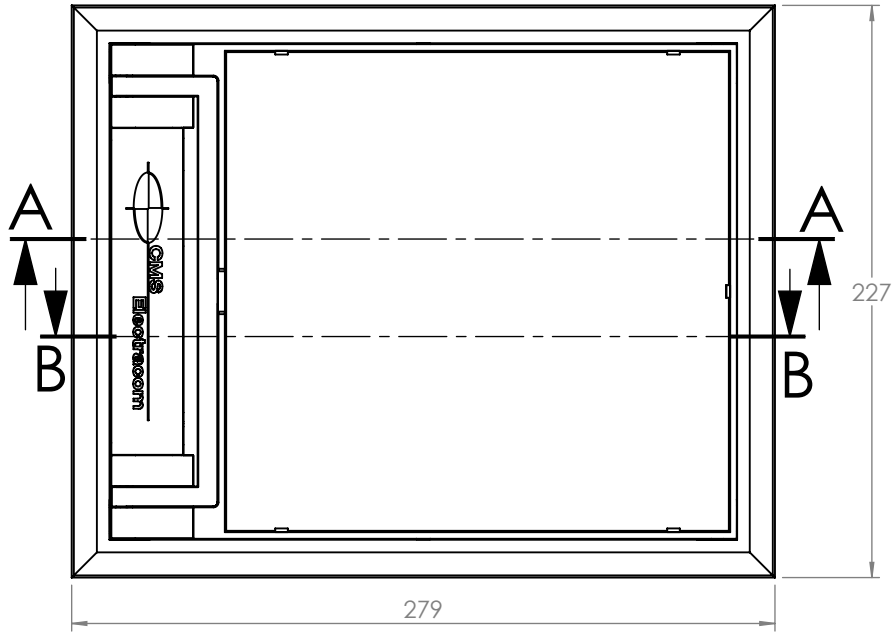

TOP VIEW

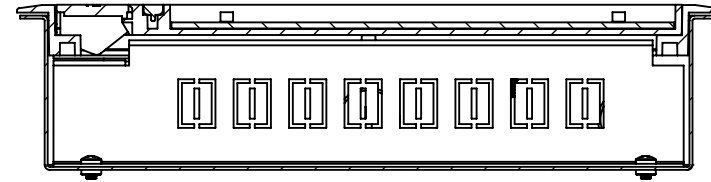

SECTION A-A  
SCALE 1 : 3

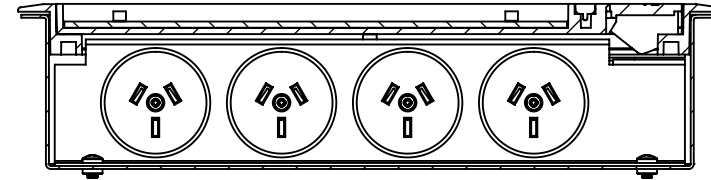

SECTION B-B  
SCALE 1 : 3

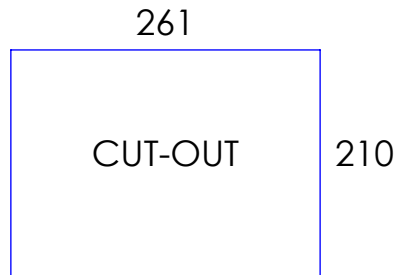

REVISION HISTORY		UNLESS OTHERWISE SPECIFIED: DIMENSIONS ARE IN MILLIMETERS		DO NOT SCALE DRAWING	REVISION	2
DATE	MODIFICATIONS	TOLERANCES				
11/12/12	ISSUED FOR MANUFACTURING	0.00 ± 0.02	ANGULAR ± 0.5°			
29/10/13	UPDATED KEYSTONE PLATE	0.0 ± 0.1	0 ± 0.5	TITLE:  <b>FB3060</b>		
		DIMENSIONS IN AN OBOUND ARE CRITICAL & MUST BE CHECKED				
		THE MATERIAL CONTAINED HEREIN IS THE SOLE PROPERTY OF CMS ELECTRACOM. ANY UNAUTHORIZED REPRODUCTIONS, MODIFICATIONS AND / OR DISTRIBUTION IS STRICTLY PROHIBITED.		DWG NO. <b>LU-4094</b> DRAWN BY <b>X</b>		
		NAME	DATE			
		LUCKY	29/10/13	PART NO. <b>X</b> CHECKED BY <b>X</b>		
		MATERIAL:	X	SCALE <b>NTS</b> SHEET <b>1 OF 2</b>		
		FINISH:	X			
		FILE ON SHARED\CAD:	H:\Melbourne\CAD\Current Production Drawings	A4		
		FILE ON NAS:	Z:\Work files\Floor boxes\FB\FB 60mm\Small\FB3060			

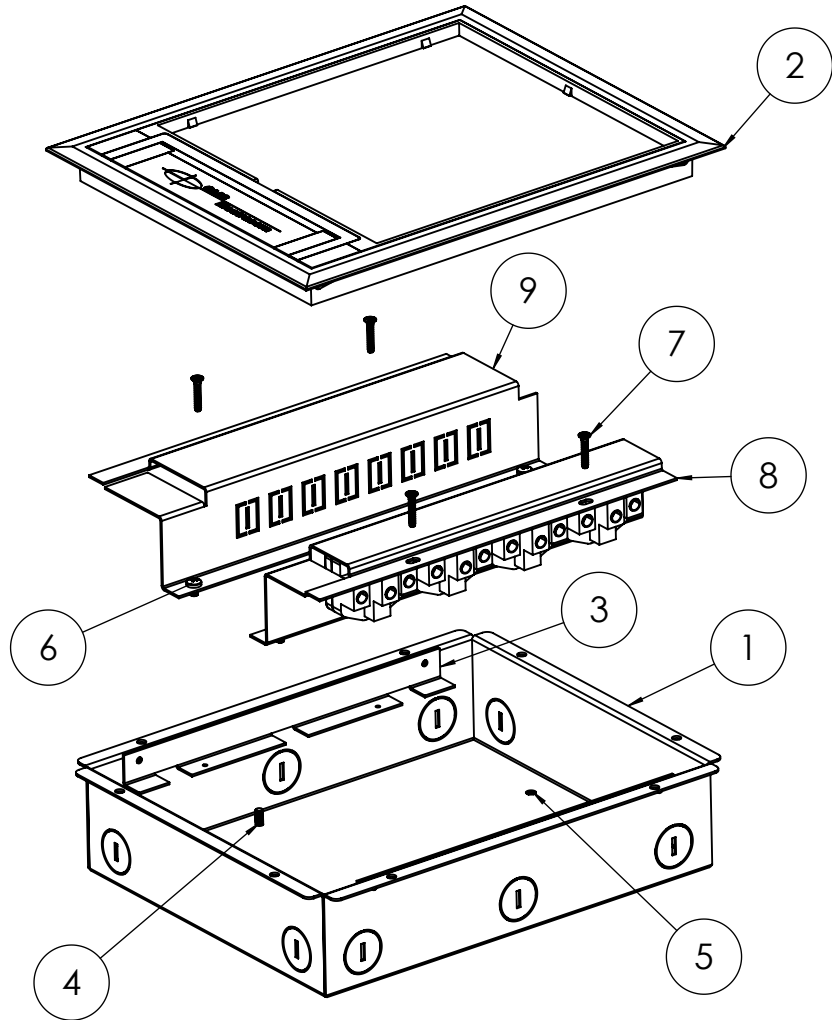

ITEM NO.	PART NUMBER	QTY.
1	LU4095_V1_FB3060 undercarriage	1
2	CMS FL3 lid	1
3	LU3410_V1_FL3 support plate	2
4	M4 x 10 flush head threaded stud	2
5	PEM M4 clinch nut	4
6	M4 x 6 pan head machine screw	4
7	6G x 3/4" blind CSK screw (To fix lid)	4
8	LU4096 ASSEMBLY	1
9	LU5807_V1_FB3060 plate with provision for 8 Keystone jacks	1

REVISION HISTORY		UNLESS OTHERWISE SPECIFIED: DIMENSIONS ARE IN MILLIMETERS TOLERANCES		DO NOT SCALE DRAWING		REVISION 2	
DATE	MODIFICATIONS	0.00 ±0.02	ANGULAR ±0.5°				
11/12/12	ISSUED FOR MANUFACTURING	0.0 ±0.1					
29/10/13	UPDATED KEYSTONE PLATE	0 ±0.5		TITLE:  <h1 style="text-align: center;">FB3060</h1>			
		DIMENSIONS IN AN OBOUNDR ARE CRITICAL & MUST BE CHECKED					
		THE MATERIAL CONTAINED HEREIN IS THE SOLE PROPERTY OF CMS ELECTRACOM. ANY UNAUTHORIZED REPRODUCTIONS, MODIFICATIONS AND / OR DISTRIBUTION IS STRICTLY PROHIBITED.					
		NAME	DATE				
		LUCKY	29/10/13				
		MATERIAL:	X	DWG NO.	LU-4094	DRAWN BY	X
		FINISH:	X	PART NO.	X	CHECKED BY	X
		FILE ON SHARED\CAD:	H:\Melbourne\CAD\Current Production Drawings	SCALE	NTS	SHEET	2 OF 2
		FILE ON NAS:	Z:\Work files\Floor boxes\FB\FB 60mm\Small\FB3060	A4			