

NOTE:

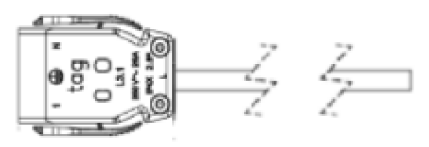

CABLE TYPE: 1.0MM
 DESCRIPTION: TAG CONNECTOR LEAD
 COLOUR: WHITE OR BLACK
 (REFER TO PURCHASE ORDER)
 LENGTH (mm):

xx	LENGTH (mm)
05	500
10	1000
15	1500
20	2000
25	2500
30	3000
35	3500
40	4000
45	4500
50	5000

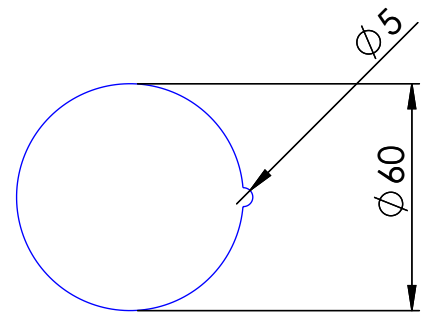

CUT-OUT
 60mm WITH 5mm NOTCH

PART NUMBER: xxXX
 NOTE - xx - LENGTH - 05 / 10 / 15 / 20 / 25 / 30 / 35 / 40 / 45 / 50
 XX - COLOUR - WT / BK

REV	DESCRIPTION	DATE	DRWN	APPV
4	LABEL ADDED	18/7/2023	JB	RG
3	LU19565 REPLACED BY LU32022, NOTE & BOM MODIFIED	23/06/2020	KV	RG
2	CABLE TYPE, NOTE & BOM MODIFIED	15/08/2019	KV	RG
1	RELEASED FOR PRODUCTION	13/11/2018	AP	JC
REVISIONS				

CUSTOMER SIGNATURE:	TOLERANCES UNLESS OTHERWISE STATED: X ±0.5 X.X ±0.2 X.XX ±0.1 X.XXX ±0.05 ANG ±0.5°
MATERIAL: PC-FR	
FINISH:	
COLOUR:	
THIS DRAWING & ASSOCIATED CAD FILES ARE ISSUED IN THE STRICTEST CONFIDENCE AND ARE ONLY TO BE USED IN THE COMMERCIAL INTERESTS OF CMS ELECTRACOM PTY LTD	
DRAWN IN mm TO AS1100 DO NOT SCALE	

CMS Electracom COPYRIGHT © 2015

TITLE: WIRELESS CHARGE WITH L3 PLUG

DRAWING: LU29629 **REV:** 4

SCALE 1:2 SHEET 1 OF 2

A3

○ ○ 
 JOB NUMBER
 PART NUMBER

CMS Electracom
 cmselectra.com
 Max rated output: 10A, 250V~, 50Hz
 Max output for wireless charging 15W

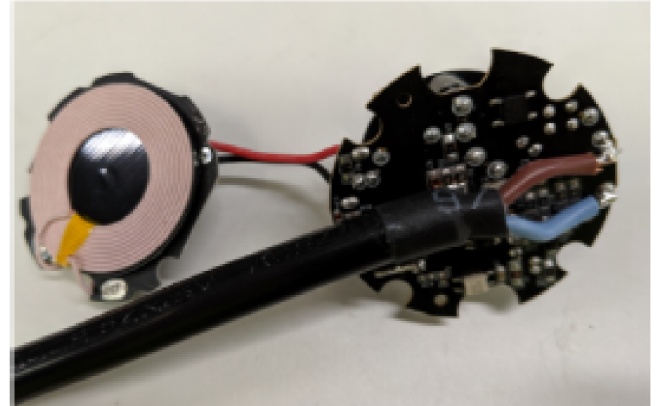
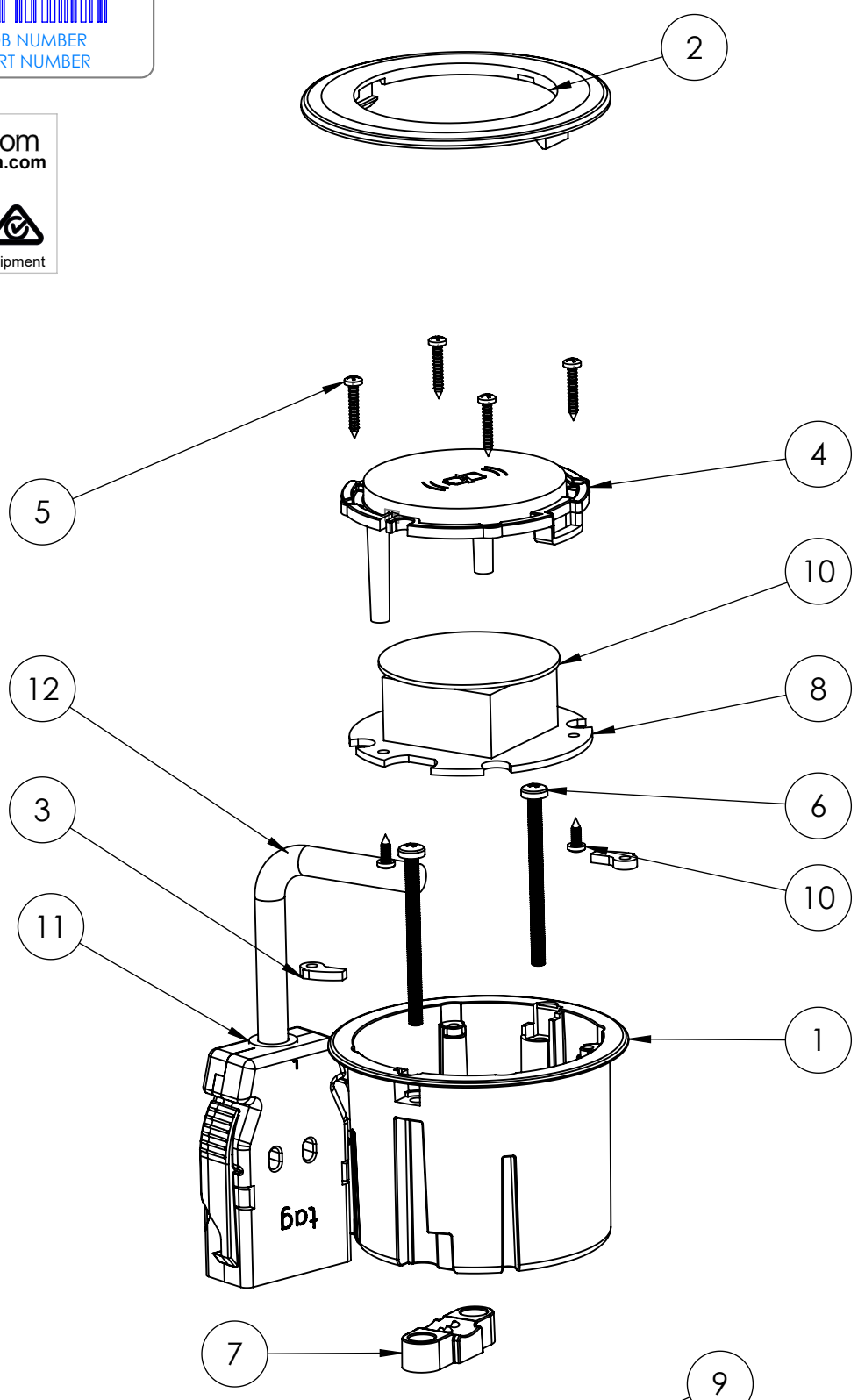
 power supply is only suitable for IT equipment



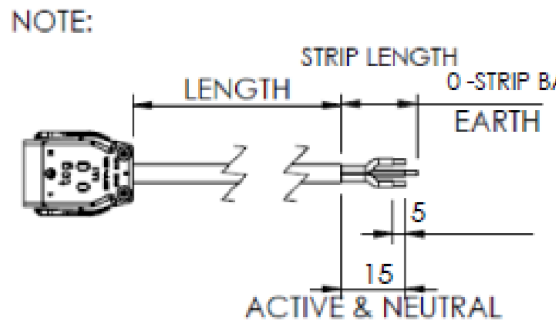

SOLDER INCOMING CABLE
 HEAT SHRINK AND POT WIRING CONNECTION

ITEM NO.	PART NUMBER	DESCRIPTION	QTY.
1	LU21780	SINGLE OUTLET HOUSING	1
2	LU21792	SINGLE OUTLET TOP COVER	1
3	LU32022	M3 threaded clamp	2
4	LU27527	SINGLE HOUSING GPO BRACKET	1
5	-	2G x 13mm Pan Head Self Tapping Screw	4
6	-	M3 x 40 Pan Head Machine Screw	2
7	LU22375	STRAIN RELIEF FOR SINGLE OUTLET HOUSING	1
8	LU27576	Eclipse wireless 15W power PCB	1
9	-	M3 x 10 Pan Head Machine Screw	2
10	-	2G x 1/4 pan head self tapping screw	2
11	2091005	Silicone sleeve (8mm)	1
12	TAG LEAD	REFER TO NOTE	1



CABLE TYPE: 1.0mm²
 DESCRIPTION: L3 CONNECTOR
 LENGTH: REFER TO PURCHASE ORDER
 COLOUR: WHITE OR BLACK (REFER TO PURCHASE ORDER)

CUSTOMER SIGNATURE:	TOLERANCES UNLESS OTHERWISE STATED: X ±0.5 X.X ±0.2 X.XX ±0.1 X.XXX ±0.05 ANG ±0.5°
MATERIAL: P.C	
FINISH:	
COLOUR:	
THIS DRAWING & ASSOCIATED CAD FILES ARE ISSUED IN THE STRICTEST CONFIDENCE AND ARE ONLY TO BE USED IN THE COMMERCIAL INTERESTS OF CMS ELECTRACOM PTY LTD	
DRAWN IN mm TO AS1100 DO NOT SCALE 	

 **CMS Electracom** COPYRIGHT © 2015

TITLE: WIRELESS CHARGE WITH L3 PLUG

DRAWING: LU29629	REV: 4	A3
SCALE 1:5	SHEET 2 OF 2	