

CMS INSTALLATION GUIDE

ACCESS FLOOR BOX APPLICATION - FTA4

STEP 1 -
CUT HOLE INTO FLOORING FOLLOWING THE LISTED CUT-OUT DIMENSIONS

STEP 2 -
INSTALL THE UNDERCARRIAGE INTO THE CUT-OUT AND SCREW FIX IN PLACE

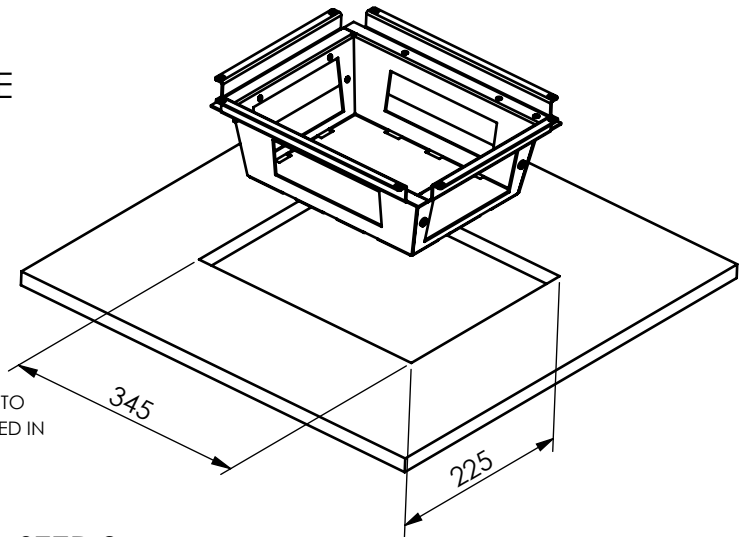

SECURE ALL DATA AND AV PLATES USING THE SCREWS PROVIDED

INSTALL GPO ENSURING EARTH LEAD IS SECURED TO THE EARTH STUD PROVIDED IN THE UNDERCARRIAGE

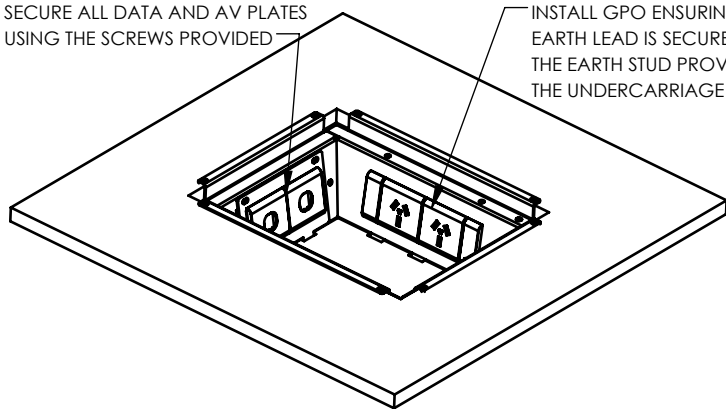

STEP 3 -
TERMINATE ALL GPO DATA AND AV OUTLETS INTO THE MOUNTING PLATES AND INSTALL TO THE UNDERCARRIAGE USING THE SCREWS PROVIDED.

STEP 4 -
LAY CARPET AND CUT OUT HOLE FOR THE LID TO FIT- USE CUT PEICE TO INSTALL INTO RECESS (IF APPLICABLE) INSTALL AND SECURE THE LID FRAME TO THE FLOORBOX UNDERCARRIAGE USING THE FIXING SCREWS PROVIDED

NOTE: THE LID IS ADJUSTABLE TO ACCOMODATE VARYING CARPET THICKNESS

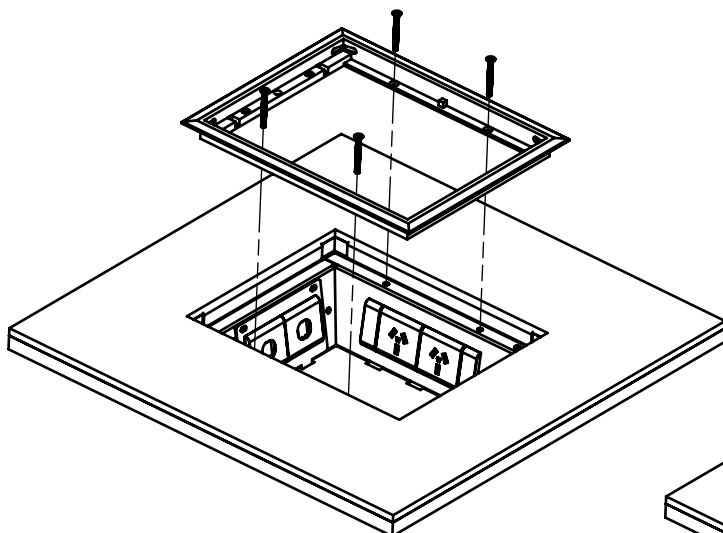

CARPET AND INFILL

