

Century Series

Provision For 4 Standard Outlet Plates

Our Century Series Floor Box is designed with the ability to be installed into either Concrete or Access Floor. Each angled mounting plate offers easy cable pass-through. It can be easily fitted with a wide variety of Power, Data and AV Switch Plates including our C-Series range.



Century 4-Compartment Shown With Dual GPO Wall Plates - C16H.2WT

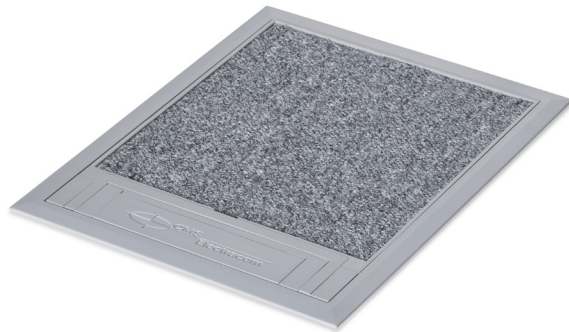

4-Comp Polycarbonate Recessed Lid

Key Features

- » Easy-grab handle and functional cable exit when lid closed
- » Provision for 4 standard outlet plates to suit a wide variety of Power, Data and AV requirements
- » Angled mounting plates with cable passthrough underneath
- » Suit both screed and raised floor applications
- » 25 & 32mm knock-outs to suit large data access requirements
- » CAT6 & CAT6A compliant

Product Details

CT04GY	Century Floorbox 4 x Provision For Standard Outlet Plates With Plastic Recess Lid - 100mm Deep
C16H.1WT	Single 10amp GPO Switched - Hardwired
C16H.2WT	Double 10amp GPO Switched - Hardwired
CSW1WT	Data Provision Plate - Single
CSW2WT	Data Provision Plate - Dual
CSW3WT	Data Provision Plate - Triple
CSW4WT	Data Provision Plate - Quad
CSW0WT	Data Provision Plate - Blank

Technical Specification

Capacity	4 x Provision For Standard Outlet Plates
Floor Application	Screed; Access Floor
Box Cut-Out / Depth	L261mm x W212mm x D100mm
Lid Finish Options	Polycarbonate With Galvanised Plate - Grey
Lid Recess Dimension	Plastic - L201 x W191mm x D7mm
Weight Rating	120kg
Undercarriage	Powder-Coated Steel (Black)

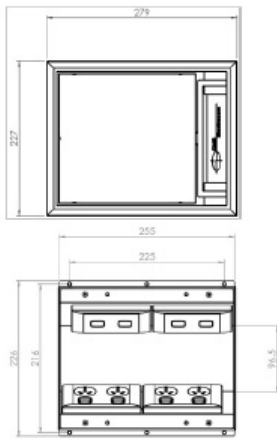

SECTION THRU-BOX

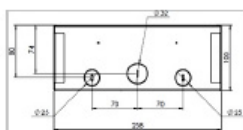
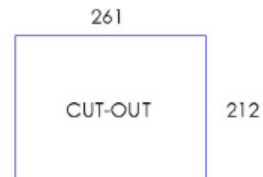
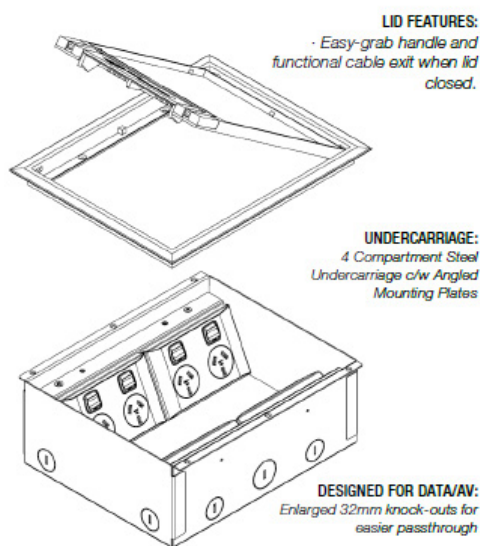

CONDUIT LOCATION 1
 Outlet Sides
 Enlarged 32mm knock-out for easier passthrough

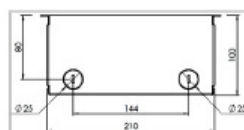

CONDUIT LOCATION 2
 Hinge & Exit Sides
 Standard 25mm knock-out

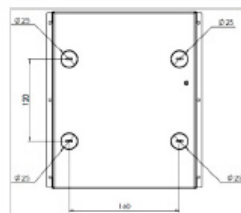

CONDUIT LOCATION 3
 Base Box
 Standard 25mm knock-outs

Disclaimer: CMS has made every attempt to ensure the accuracy and reliability of the information provided in this document are correct. All information contained in this document is to be used for general guidance only. CMS reserves the right to change, delete or modify the information without notice.

© CMS Electracom 2023