

USE LU21933 WHEN INSTALLING GPO

FACTORY ONLY INSERTABLE MODULES
REFER PAGE 2 FOR
MODULE CONFIGURATION

AU/NZ SOCKET OUTLET = AU

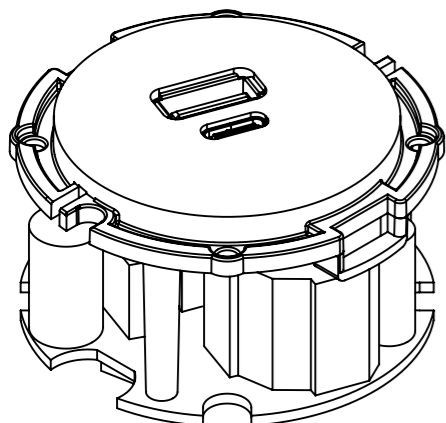

USB AC MODULE = U

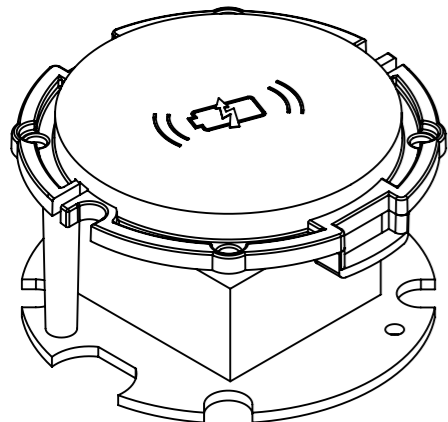

WIRELESS CHARGING MODULE = W

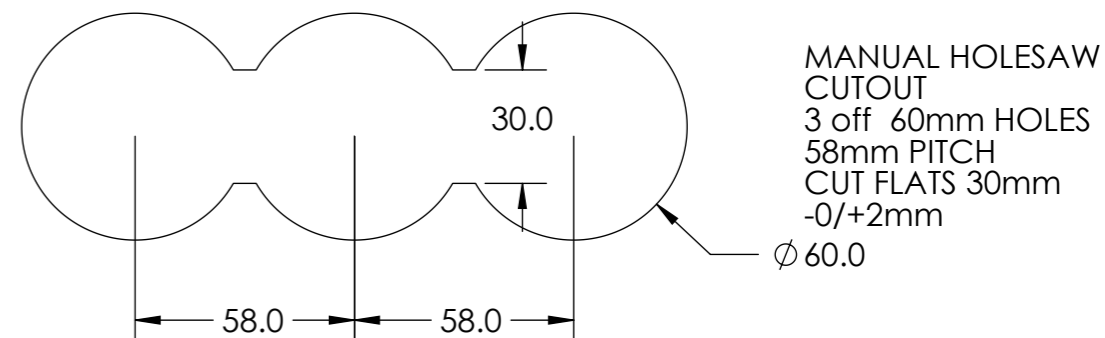
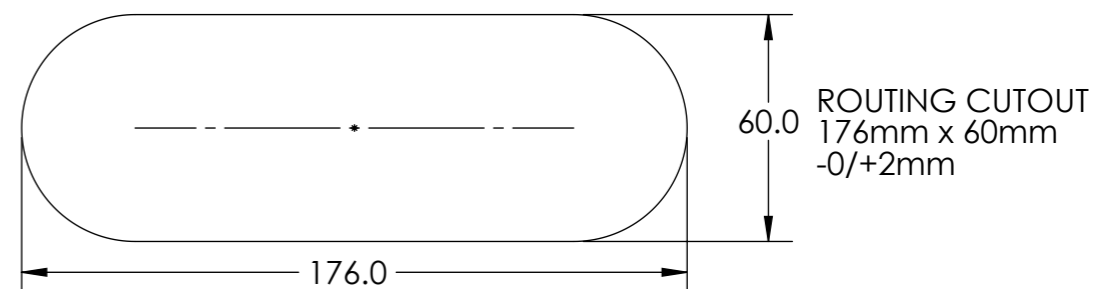
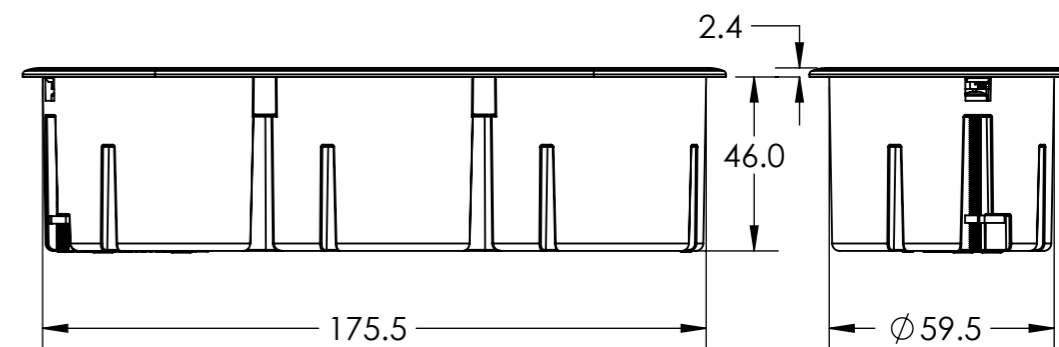
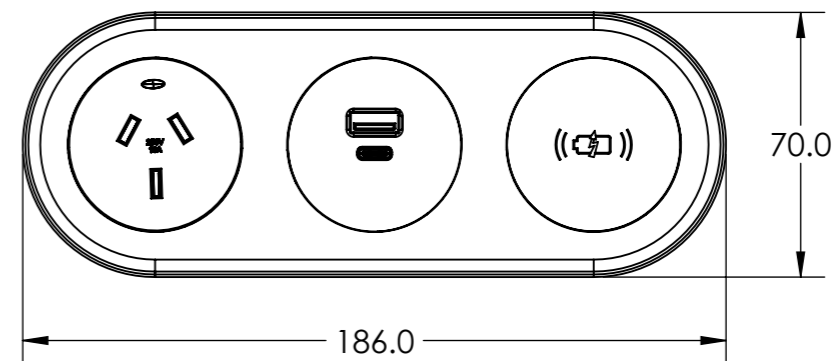
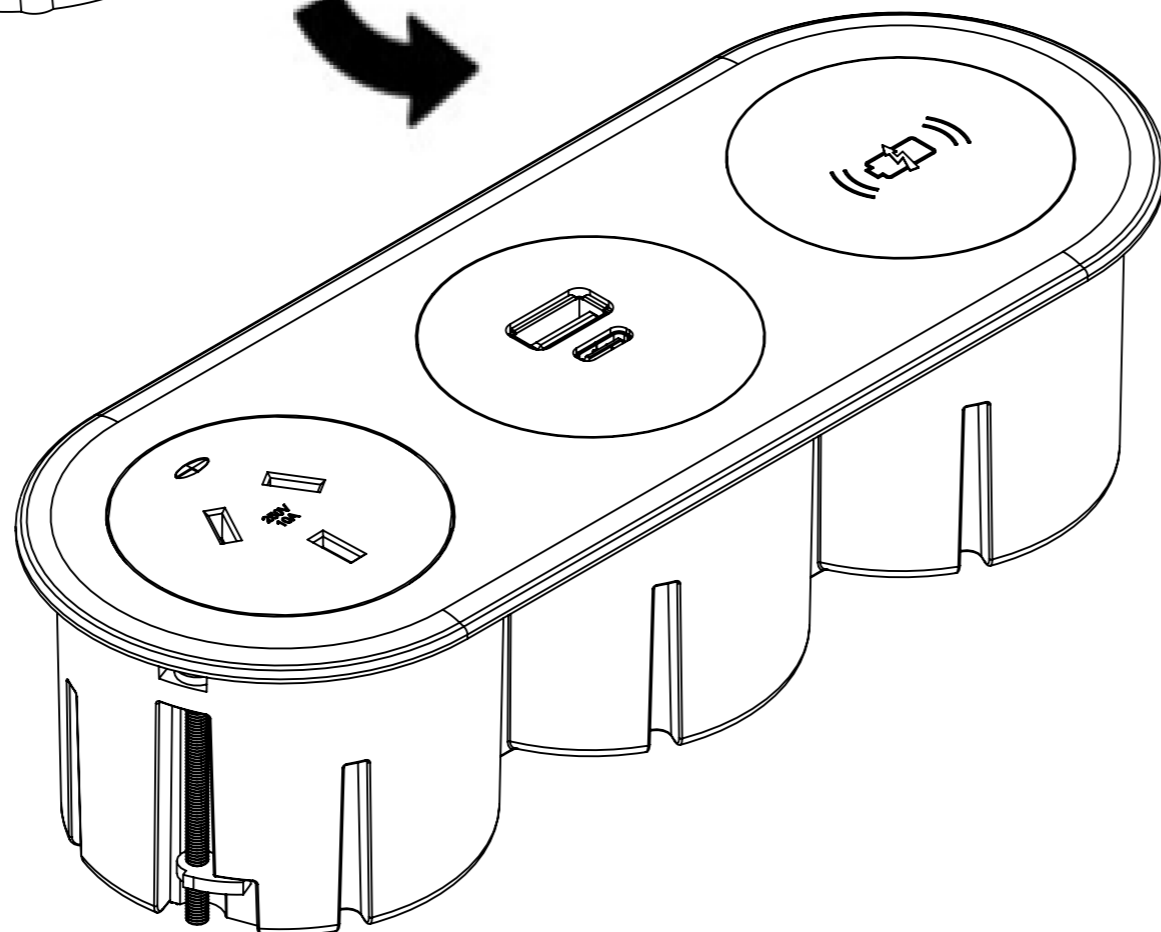

ROUTING CUTOUT
176mm x 60mm
-0/+2mm

MANUAL HOLESAW
CUTOUT
3 off 60mm HOLES
58mm PITCH
CUT FLATS 30mm
-0/+2mm

CUSTOMER SIGNATURE:		TOLERANCES UNLESS OTHERWISE STATED:		 CMS Electracom <small>COPYRIGHT © 2015</small>	
MATERIAL: PC FR		X ±0.5 X.X ±0.2 X.XX ±0.1 X.XXX ±0.05 ANG ±0.5°		TITLE: AU MULTI 3 ECHO ASSEMBLY	
FINISH: TEXTURED		COLOUR: WHITE OR BLACK		DRAWING: LU36240	
REVISIONS		THIS DRAWING & ASSOCIATED CAD FILES ARE ISSUED IN THE STRICTEST CONFIDENCE AND ARE ONLY TO BE USED IN THE COMMERCIAL INTERESTS OF CMS ELECTRACOM PTY LTD		REV: 1	
1	RELEASED FOR EVALUATION	2/09/2019	AP	A3	
REV	DESCRIPTION	DATE	DRWN	SCALE 1:2	
				SHEET 1 OF 4	

1	RELEASED FOR EVALUATION	2/09/2019	AP	
REV	DESCRIPTION	DATE	DRWN	APPV
REVISIONS				

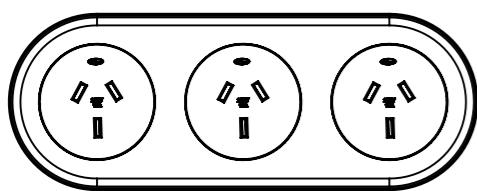

ETA1A1A1XXXDXX

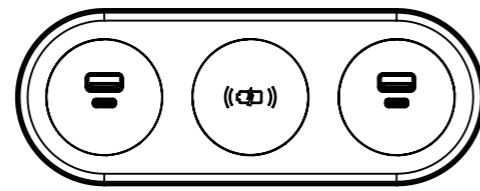

ETUWUXXXDXX

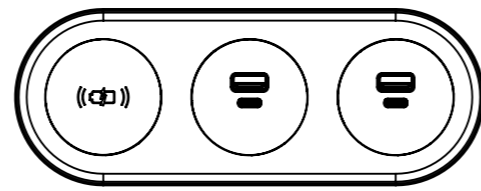

ETWUWXXXDXX

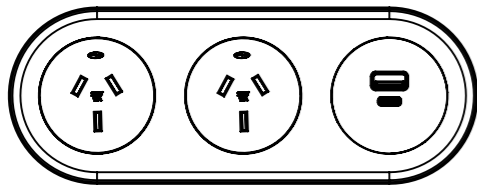

ETA1A1UXXXDXX

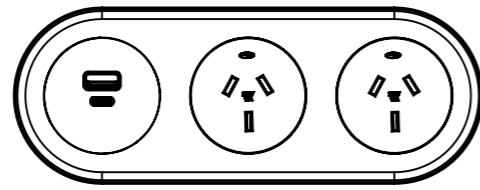

ETUA1A1XXXDXX

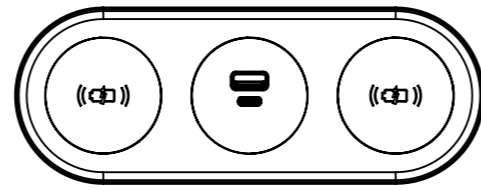

ETWUWXXXDXX

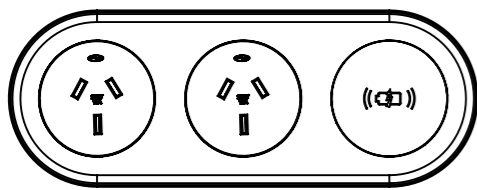

ETA1A1WXXXDXX

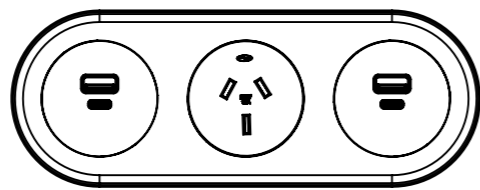

ETUA1UXXXDXX

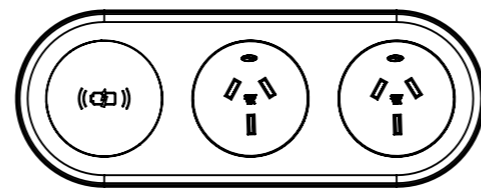

ETUA1A1XXXDXX

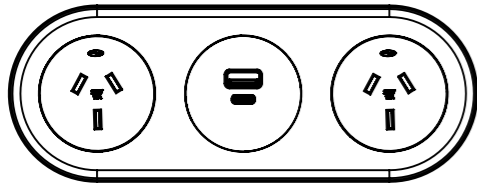

ETA1UA1XXXDXX

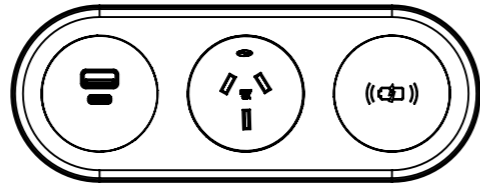

ETUA1WXXXDXX

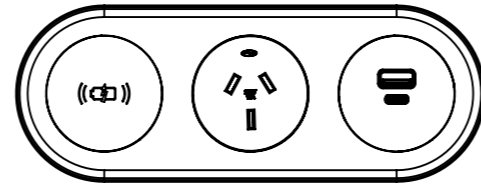

ETWA1UXXXDXX

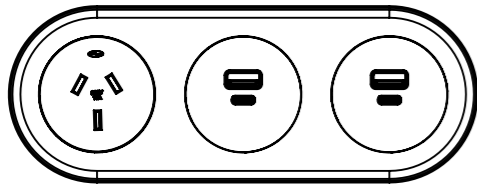

ETA1UUXXXDXX

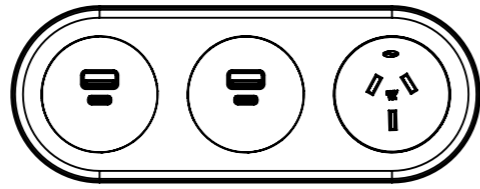

ETUUA1XXXDXX

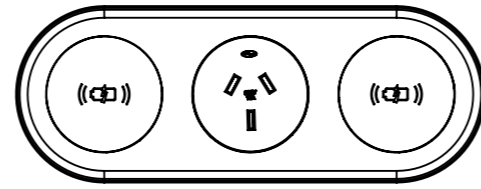

ETWA1WXXXDXX

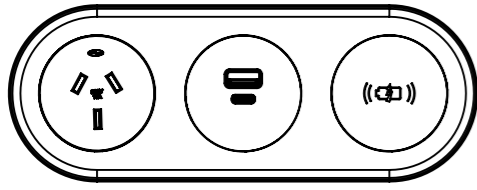

ETA1UWXXXDXX

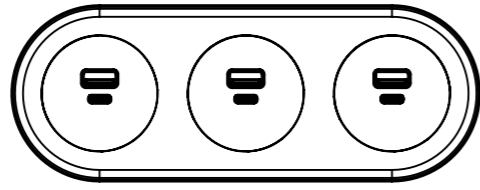

ETUUUXXXDXX

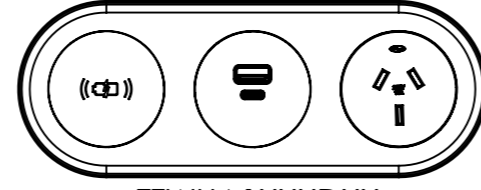

ETWUA1XXXDXX

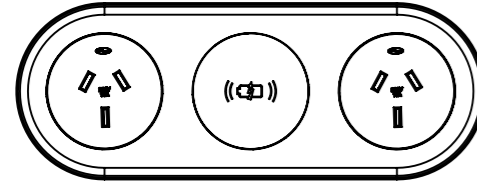

ETA1WA1XXXDXX

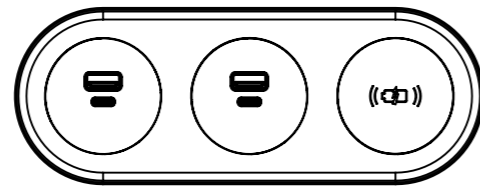

ETUWUXXXDXX

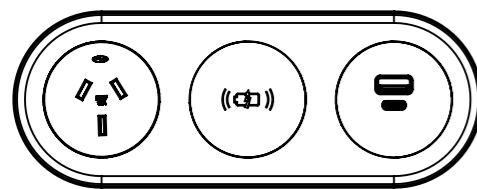

ETA1WUXXXDXX

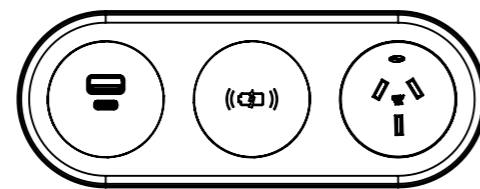

ETUWA1XXXDXX

NOTE:

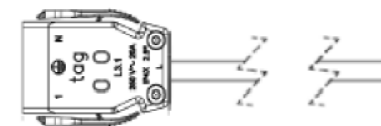

CABLE TYPE: 2.5MM
DESCRIPTION: TAG CONNECTOR LEAD
COLOUR: WHITE OR BLACK
(REFER TO PURCHASE ORDER)
LENGTH (mm):

xx	LENGTH (mm)
05	500
10	1000
15	1500
20	2000
25	2500
30	3000
35	3500
40	4000
45	4500
50	5000

NOTE:

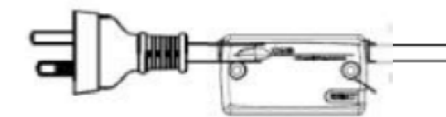

CABLE TYPE: 1MM
DESCRIPTION: AUSTRALIAN PLUG LEAD
WITH THERMAL OVERLOAD
COLOUR: WHITE OR BLACK
(REFER TO PURCHASE ORDER)
LENGTH (mm):

xx	LENGTH (mm)
05	500
10	1000
15	1500
20	2000
25	2500
30	3000
35	3500
40	4000
45	4500
50	5000

PART NUMBER: ETA1A1A1XxxDXX

NOTE - X - LEAD TYPE (TAG OR 3PIN PLUG)
xx - LENGTH - 05 / 10 / 15 / 20 / 25 / 30 / 35 / 40 / 45 / 50
XX - COLOUR - WT / BK / (BK/BK) / (WT/WT) / (WT/WM)

CUSTOMER SIGNATURE:	TOLERANCES UNLESS OTHERWISE STATED: X ±0.5 X.X ±0.2 X.XX ±0.1 X.XXX ±0.05 ANG ±0.5°	 CMS Electracom <small>COPYRIGHT © 2015</small>		
MATERIAL:				TITLE: AU MULTI 3 ECHO ASSEMBLY
FINISH:		WHITE OR BLACK	DRAWING:	REV:
COLOUR:			LU36240	1
THIS DRAWING & ASSOCIATED CAD FILES ARE ISSUED IN THE STRICTEST CONFIDENCE AND ARE ONLY TO BE USED IN THE COMMERCIAL INTERESTS OF CMS ELECTRACOM PTY LTD		DRAWN IN mm TO AS1100 DO NOT SCALE	SCALE 1:2	SHEET 2 OF 4

A3