

SECTION A-A
SCALE 1 : 4

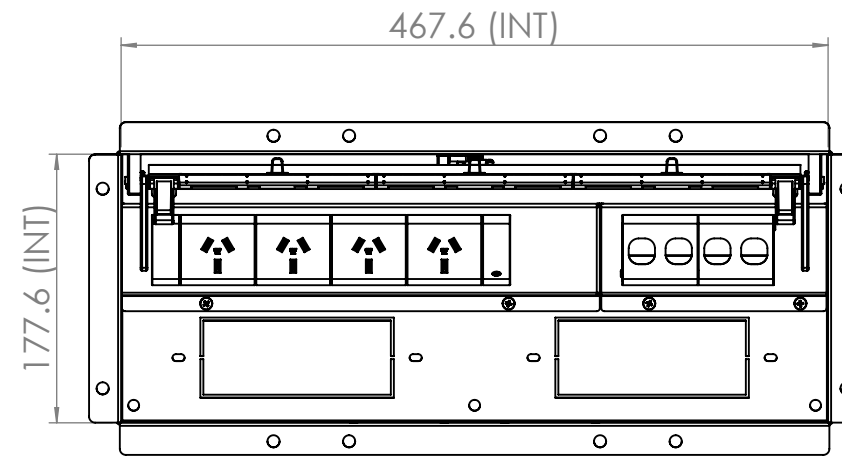

TOP VIEW - LID OPEN

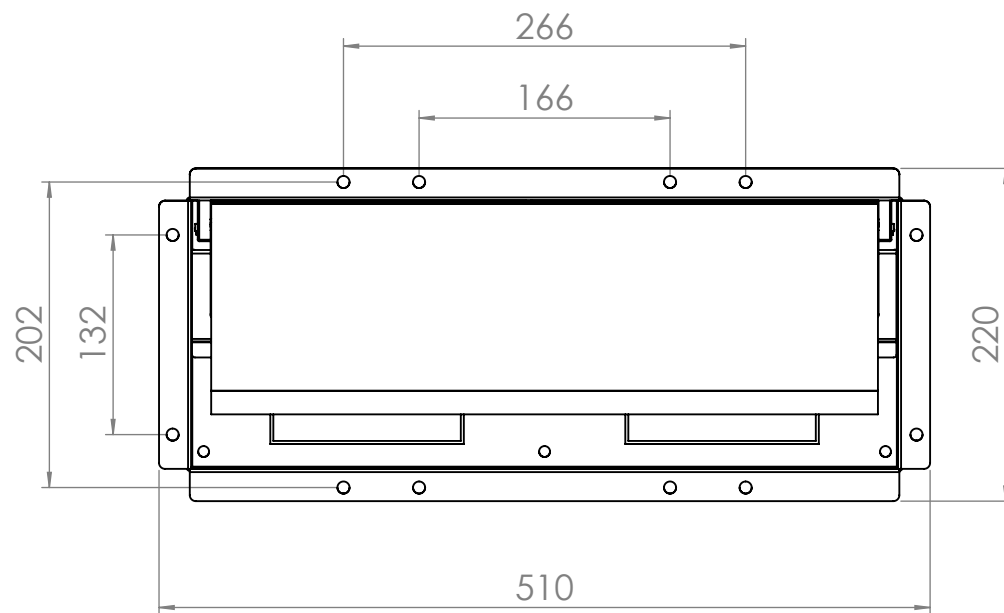
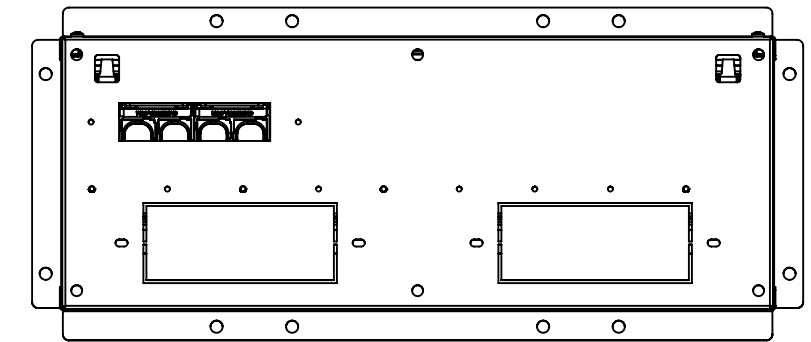

BOTTOM VIEW

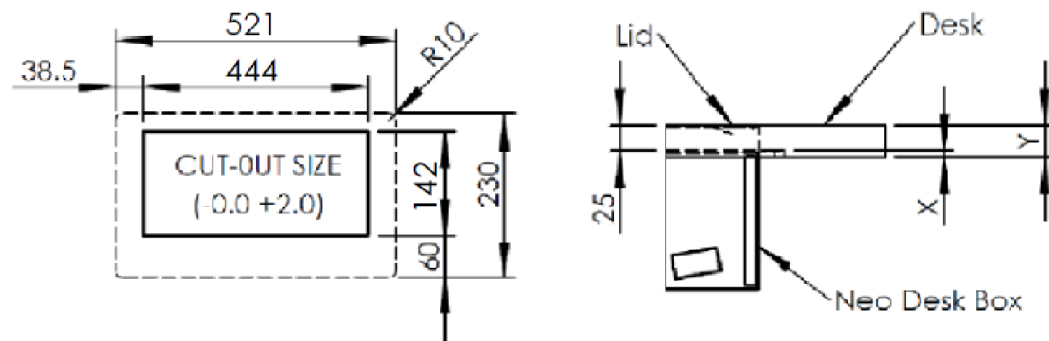

SECTION

Note:
Dashed line shows Rebate Perimeter
(Only needed when Desk thickness is
greater than 25mm.)
For Rebate Depth:
Desk Thickness(Y) - 25mm = Rebate(X)

PART NUMBER: NE10404

CUSTOMER SIGNATURE:	TOLERANCES UNLESS OTHERWISE STATED:	 CMS Electracom <small>COPYRIGHT © 2020</small>
MATERIAL: POLYCARBONATE / MILD STEEL / ALUMINIUM	X ±0.5 X.X ±0.2 X.XX ±0.1 X.XXX ±0.05 ANG ±0.5°	
FINISH: FINE EDM / POWDER COATED / BEAD BLASTED		
COLOUR: GPO BLACK / SMOOTH BLACK / SILVER		
THIS DRAWING & ASSOCIATED CAD FILES ARE ISSUED IN THE STRICTEST CONFIDENCE AND ARE ONLY TO BE USED IN THE COMMERCIAL INTERESTS OF CMS ELECTRACOM PTY LTD		TITLE: NE10404 NEO SLB 4 GPO + 4 DATA
DRAWN IN mm TO AS1100 DO NOT SCALE		DRAWING: LU41201
REVISIONS		REV: 2
SCALE 1:5		A3
SHEET 1 OF 3		

REV	DESCRIPTION	DATE	DRWN	APPV
2	UPDATED BOM/ADDED REBATE DETAILS	06/07/2023	GC	AP
1	RELEASED FOR PRODUCTION	20/09/2022	AB	AP