

In Desk Box Application

Type: Flip Surface Mount - 2 x GPO only.

Part No: FS0200**

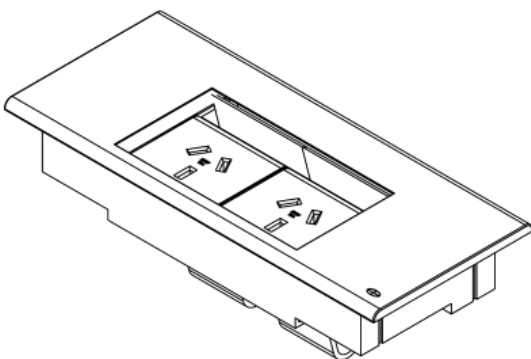
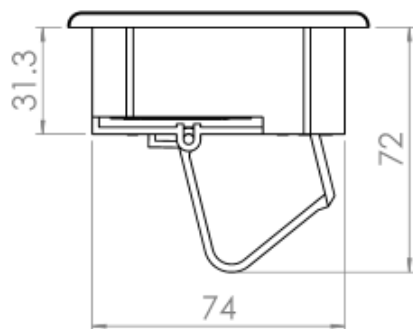
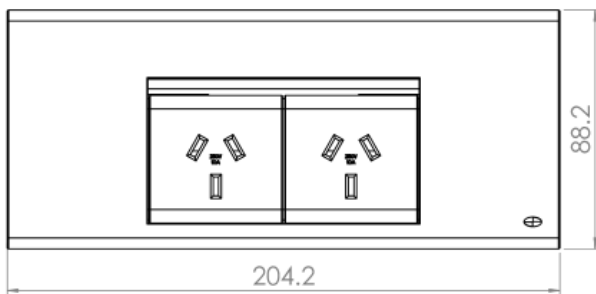
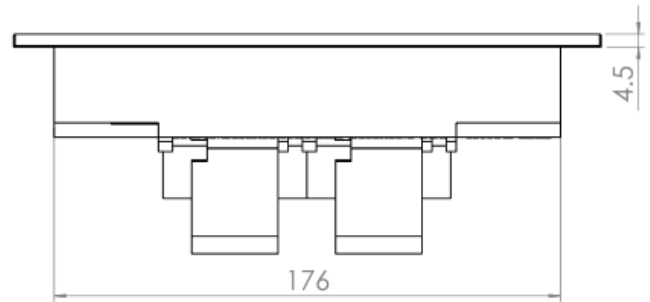
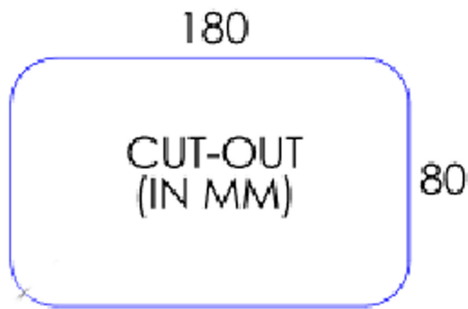

- STEP 1:** CREATE CUT OUT IN TABLE TO SUIT SPECIFIC BOX
- STEP 2:** POSITION BOX INTO CUTOUT
- STEP 3:** REMOVE TOP COVER FROM THE FLIP UNIT
- STEP 4:** DRILL PILOT HOLES (2 AT EACH END)
- STEP 5:** SCREW FIX FLIP UNIT INTO PLACE WITH THE SCREWS PROVIDED
- STEP 6:** CLIP TOP COVER PLATE BACK ON

FOR MORE INFORMATION GO TO:
www.cmselectra.com