

IN DESK ROUTING DETAIL

BRACKET ADJUSTABLE TO SUIT 18MM - 20MM, 25MM & 31MM THICK TABLE TOPS. REFER LU47985

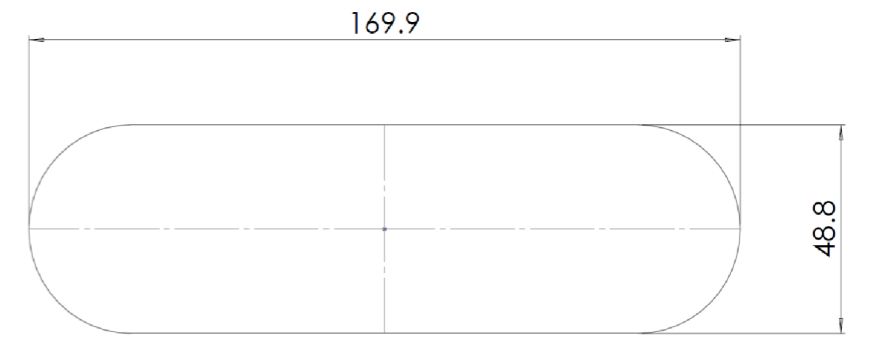

ROUTING CUTOUT
169.9mm X 48.8mm
-0/+0.25mm

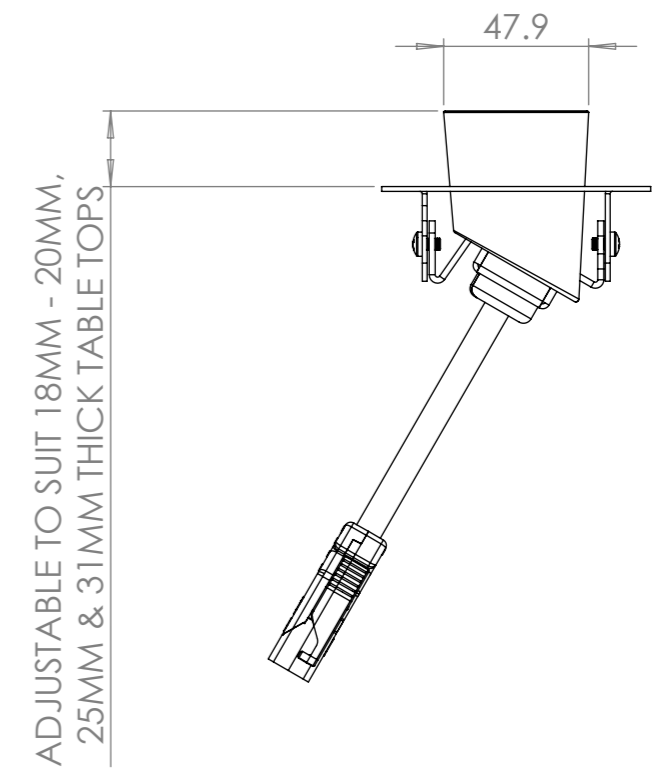

REV	DESCRIPTION	DATE	DRWN	APPV
8	IN DESK CUTOUT REDUCED BY -0.6MM	13/10/2025	JB	AP
7	BRACKET UPDATED TO SLOTS ON ONE SIDE	26/8/2025	JB	AP
6	COLOUR TABLE UPDATED	7/7/2025	JB	RG
5	IN DESK BRACKET DESIGN UPDATE, BOM UPDATED	1/7/2025	JB	RG
4	IN DESK BRACKET DESIGN UPDATE, BOM UPDATED	26/6/2025	JB	RG
3	STAINLESS DECAL NOTE UPDATED	2/5/2025	JB	RG
2	BOM NOTE ADDED TO INCLUDE ADDITIONAL PART WITH STAINLESS DECAL	10/4/2025	JB	RG
1	RELEASED FOR PRODUCTION	27/3/2025	JB	RG
REVISIONS				

CUSTOMER SIGNATURE:
MATERIAL: PC FR
FINISH: FINE EDM / POLISHED
COLOUR: REFER TABLE
THIS DRAWING & ASSOCIATED CAD FILES ARE ISSUED IN THE STRICTEST CONFIDENCE AND ARE ONLY TO BE USED IN THE COMMERCIAL INTERESTS OF CMS ELECTRACOM PTY LTD

TOLERANCES UNLESS OTHERWISE STATED:
X ±0.5
X.X ±0.2
X.XX ±0.1
X.XXX ±0.05
ANG ±0.5°
DRAWN IN mm TO AS1100 DO NOT SCALE

 **CMS Electracom** COPYRIGHT © 2020

TITLE:
NOVA TRIO IN DESK AU CONFIGURATIONS

DRAWING: LU47979	REV: 8	A3
SCALE 1:2	SHEET 1 OF 6	

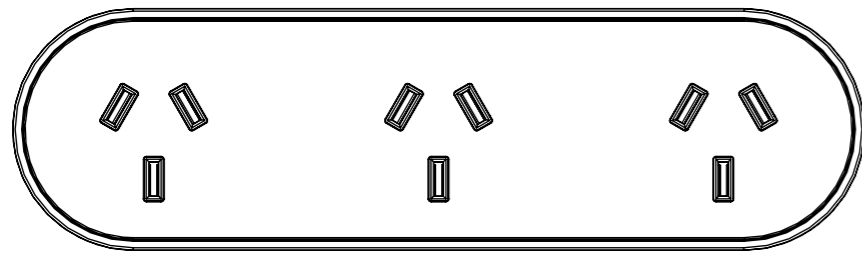

NTMAAAXxxXX

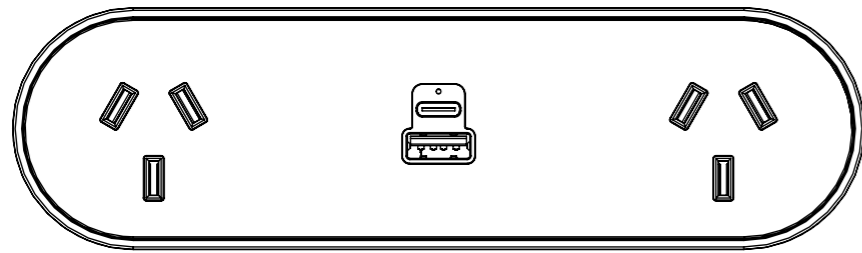

NTMAUAXxxXX

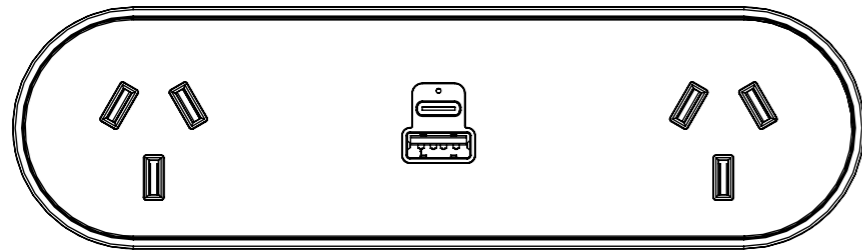

NTMAWAXxxX

COLOUR VARIATIONS	
PART NUMBER	DESCRIPTION
W	WHITE BODY & CLAMP
B	BLACK BODY & CLAMP
1	WHITE DECAL GLOSS
2	WHITE DECAL MATT
3	BLACK DECAL GLOSS
4	BLACK DECAL MATT
LUX DECAL OPTIONS	
BSB	PRESTIGE GOLD, SATIN (BRUSHED)
BZB	QUARTZ BRONZE SATIN (BRUSHED)
SSB	STAINLESS STEEL NO.4 (BRUSHED)
BSM	PRESTIGE GOLD GRANEX (MATTE)
BZM	QUARTZ BRONZE GRANEX (MATTE)
SSM	NATURAL GRANEX (MATTE)
BKM	BLACK GRANEX (MATTE)

NOTE:

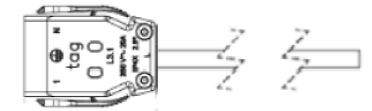

CABLE TYPE: 3 CORE x 2.5mm²
 DESCRIPTION: TAG CONNECTOR LEAD
 COLOUR: WHITE OR BLACK
 (REFER TO PURCHASE ORDER)
 LENGTH (mm):

xx	LENGTH (mm)
05	500
10	1000
15	1500
20	2000
25	2500
30	3000
35	3500
40	4000
45	4500
50	5000

NOTE:

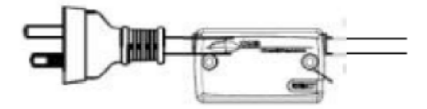

CABLE TYPE: 3 CORE x 1.0mm²
 DESCRIPTION: AUSTRALIAN PLUG LEAD
 WITH THERMAL OVERLOAD
 COLOUR: WHITE OR BLACK
 (REFER TO PURCHASE ORDER)
 LENGTH (mm):

xx	LENGTH (mm)
05	500
10	1000
15	1500
20	2000
25	2500
30	3000
35	3500
40	4000
45	4500
50	5000

PART NUMBER: (REFER CONFIGURATION)XxxXX

NOTE - * - CLAMP TYPE - (M = IN DESK)
 X - LEAD TYPE (TAG = T OR 3PIN PLUG = I)
 xx - LENGTH - 05 / 10 / 15 / 20 / 25 / 30 / 35 / 40 / 45 / 50
 XX - COLOUR - W / B + 1 / 2 / 3 / 4

CUSTOMER SIGNATURE:	TOLERANCES UNLESS OTHERWISE STATED: X ±0.5 X.X ±0.2 X.XX ±0.1 X.XXX ±0.05 ANG ±0.5°	 CMS Electracom <small>COPYRIGHT © 2020</small>		
MATERIAL: PC FR				TITLE: NOVA TRIO IN DESK AU CONFIGURATIONS
FINISH: FINE EDM / POLISHED		DRAWING: LU47979	REV: 8	
COLOUR: REFER TABLE		SCALE 1:2	SHEET 2 OF 6	
<small>THIS DRAWING & ASSOCIATED CAD FILES ARE ISSUED IN THE STRICTEST CONFIDENCE AND ARE ONLY TO BE USED IN THE COMMERCIAL INTERESTS OF CMS ELECTRACOM PTY LTD</small>		<small>DRAWN IN mm TO AS1100 DO NOT SCALE</small> 